

CALIBRE™

RADAR AND LASER PROTECTION

INSTALLATION INSTRUCTIONS & RECOMMENDED PROCEDURES

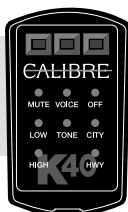

The included CALIBRE Remote Control is used to allow the driver to adjust settings on the CALIBRE and to mute audio alerts during prolonged encounters. It may be mounted virtually anywhere inside the vehicle with the included double stick tape or remain unmounted.

WARNING LED(S)

(MODELS: CALIBRE *DL/SL*)

1. Consult with vehicle owner about LED location. For best visibility, choose a mounting location as close to the vehicle gauges as possible.
2. Check for proper clearance behind the area where the LED(s) will be installed (approximately 1") and drill a 3/16" hole in the chosen location for the LED(s). CALIBRE *DL* models require the mounting of a second LED for rear radar warnings.
3. Route all of the LED wires under the dash per DIAGRAM A1.

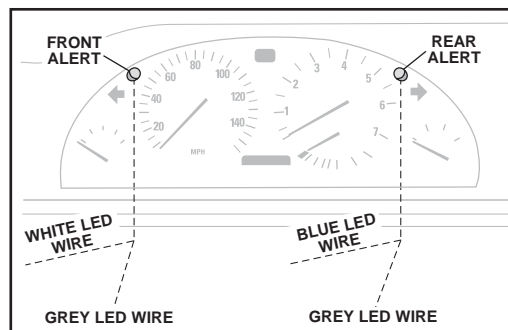

DIAGRAM A1

WARNING POD(S)

(MODELS: CALIBRE *DL-P/SL-P*)

1. Consult with vehicle owner about Pod location. For best visibility, choose a mounting location as close to the vehicle gauges as possible.
2. Before mounting the Warning Pod(s), clean both the Pod surface and desired mounting location on the dash with isopropyl alcohol.
3. Position the Warning Pod(s) on the dash with the provided double stick "O" ring tape. CALIBRE *DL-P* models require the mounting of a second Pod for rear radar warnings.
4. Route the black cable(s) from the Warning Pod(s) through or under the dash per DIAGRAM B1.

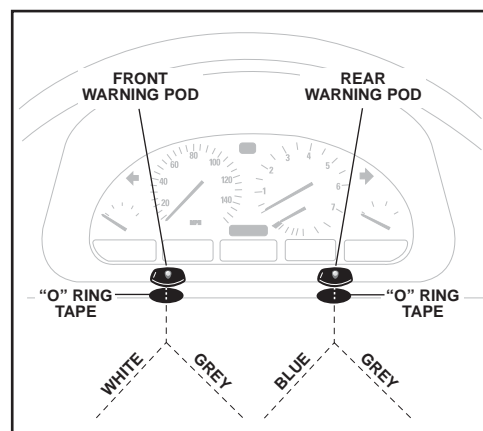
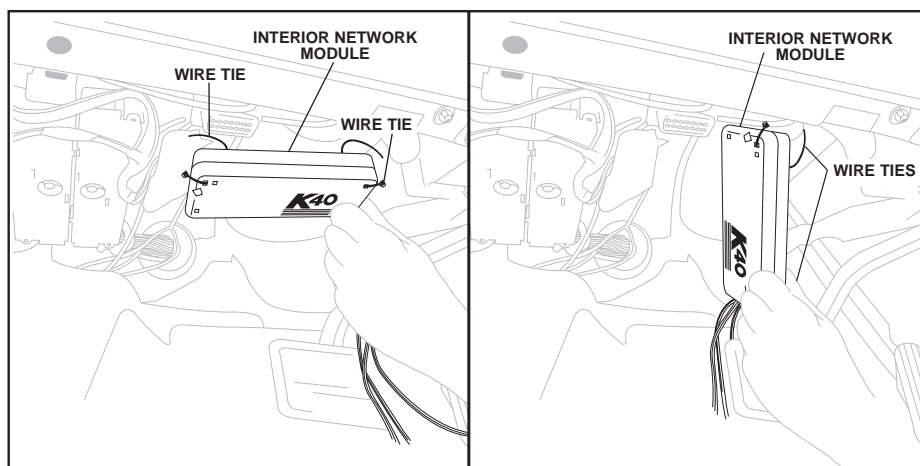

DIAGRAM B1

INTERIOR NETWORK MODULE

1. Remove the under dash panel and mount the Interior Network Module using the supplied cable ties to the existing factory wire looms, brackets, or other support structures as per DIAGRAM C1. The Interior Network Module can be mounted horizontally or vertically under the dash.
2. Connect the LED, ignition, and ground wires per the separate enclosed block diagram sheet.



HORIZONTAL MOUNT DIAGRAM C1

VERTICAL MOUNT

AMPLIFIED SPEAKER

1. Route the amplified speaker cable around a panel edge and reattach the under dash panel per DIAGRAM D1.
2. For maximum audio output and concealment, mount the amplified speaker to the outside of the under dash panel with the supplied screws per DIAGRAM D1.

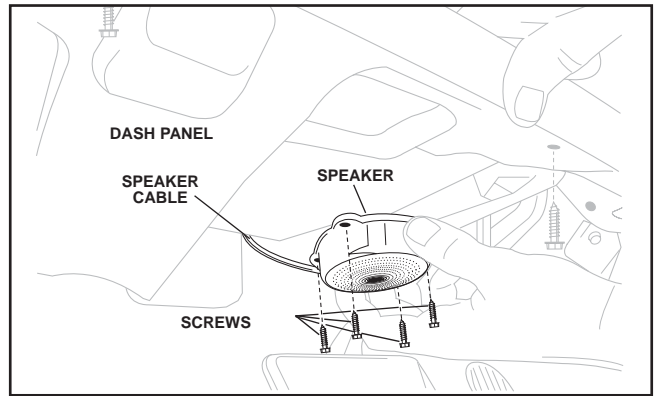

DIAGRAM D1

NOTE: *If the vehicle is not equipped with an under dash panel (e.g., Porsche), mount the amplified speaker to existing factory wire looms, brackets, or support structures with the supplied cable ties.*

FRONT RADAR RECEIVER

1. Choose a mounting location in the front of the vehicle per DIAGRAM E1. The radar receiver must be mounted horizontally with the arrows pointing forward, towards the road ahead.
2. Mount the front radar receiver with the supplied screws or wire ties to the vehicle's structure per DIAGRAM E1.
3. Route the wires to the desired connection point and connect per the separate enclosed block diagram sheet.

NOTE: *All radar receivers can be mounted behind plastic, rubber, or fiberglass up to 1/4" thick. Do not mount radar receiver behind metal, carbon fiber or chromed plastic.*

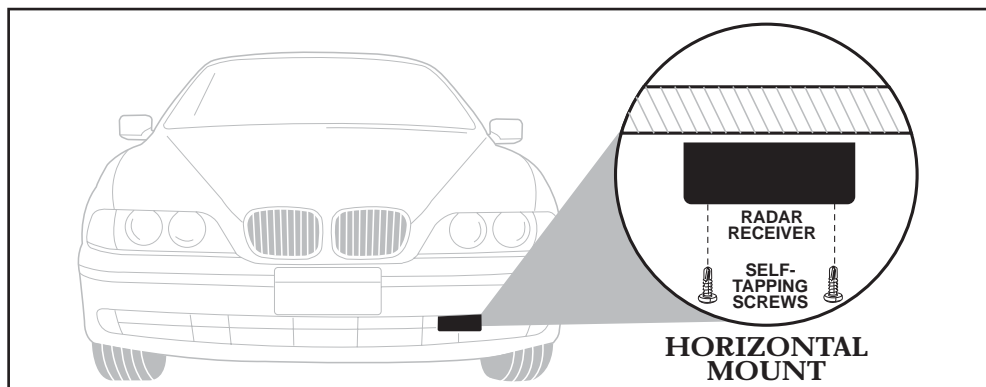

DIAGRAM E1

REAR RADAR RECEIVER

1. The rear radar receiver can be fastened to the vehicle using the supplied self-tapping screws or cable ties. See DIAGRAM F1.
2. Route the rear radar receiver cable into trunk through factory grommet.
3. If a factory grommet is not available, use the provided strain relief:
 - a. Choose a location in the trunk compartment as close to the radar receiver as possible.
 - b. Drill a 1/2" hole into the chosen location for the strain relief.
 - c. Install the strain relief and tighten the mounting nut securely.
 - d. Route the rear radar receiver cable through the strain relief, leaving a little slack in the receiver cable.
 - e. Tighten the waterproof gasket nut to create a waterproof seal.
4. Connect wires per the separate enclosed block diagram sheet.

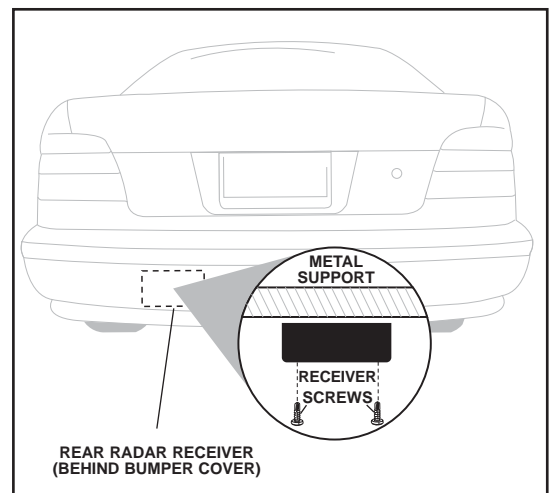

DIAGRAM F1