

IGNITION AND GROUND

1. USE A TEST METER TO LOCATE A +12v IGNITION SWITCH SOURCE FOR THE HOST.
2. CONNECT THE BLACK WIRE TO A SOLID CHASSIS GROUND (K40 RECOMMENDS THE DRIVER'S SIDE KICK PANEL) USING THE PROVIDED RING TERMINAL AND SILVER SELF-TAPPING SCREW.

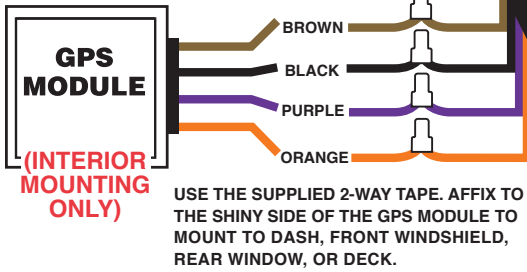

*NOTE: DRILL 3/16" HOLE FOR LED.

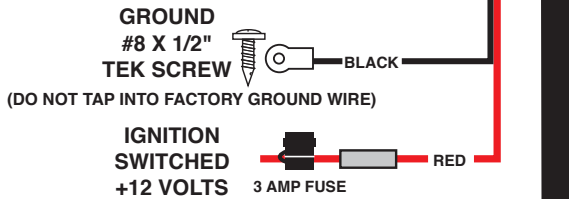
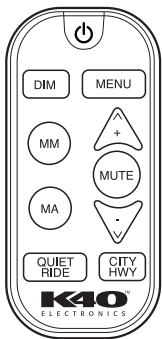
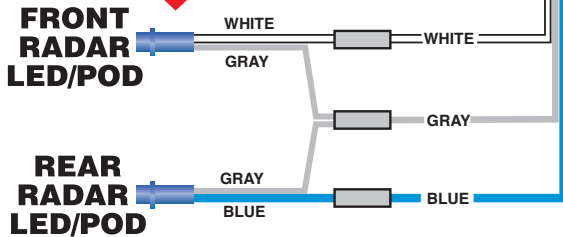

REMOTE CONTROL (RCUi)



SPEAKER

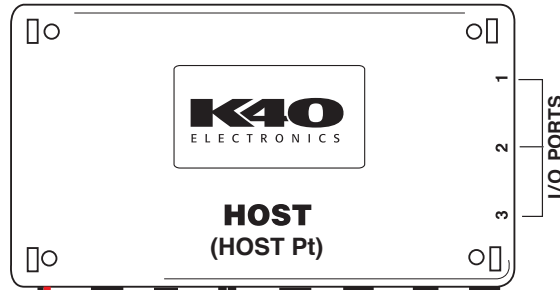

ORANGE WIRE, HEADLIGHT AUTO DIM
CONNECT TO LOW BEAM HEADLIGHT POWER (+12V) WHEN HEADLIGHTS ARE TURNED ON, ALERT LEDs AUTO DIM TO "NIGHT" MODE.

WHITE WIRE FOR HARDWIRED MUTE BUTTON
CONNECT THE WHITE MUTE IN WIRE FROM THE HOST TO AN OPEN PIN ON A NORMALLY OPEN MOMENTARY PUSH BUTTON SWITCH. CONNECT THE OTHER OPEN PIN ON THE SWITCH TO CHASSIS GROUND.

BLACK WIRE, ALERT OUTPUT
USED TO MUTE AN AFTERMARKET RADIO OR TRIGGER AN ALTERNATE ALERT COMPONENT.



DEFUSER INTERFACE MODULE

*USE L2 AND/OR L5 FOR CENTER MOUNTED DEFUSER TRANSPONDER(S) WHEN CONFIGURING FOR VPR LASER GUNS

CONNECTS TO DEFUSER INTERFACE MODULE

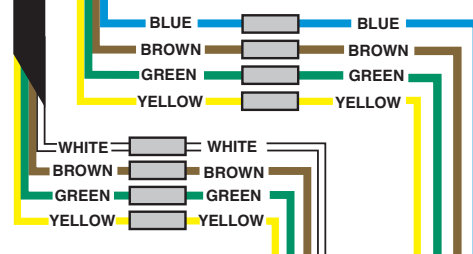
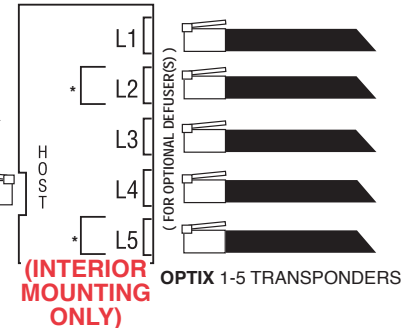

FRONT RADAR RECEIVER (PTF)

RECEIVERS MUST BE INSTALLED HORIZONTALLY. DO NOT OBSTRUCT UNIT FACE WITH METAL, CHROME-PLATED PLASTIC OR CARBON FIBER.

REAR RADAR RECEIVER (PTR)
(Platinum360 MODEL ONLY)

RECEIVERS MUST BE INSTALLED HORIZONTALLY. DO NOT OBSTRUCT UNIT FACE WITH METAL, CHROME-PLATED PLASTIC OR CARBON FIBER.